

Linear

LINI-R XL RGBW Fixture Guide

KKDÖ

Indoor | Surface | RGBW output up to 441lm/m (134lm/ft)



Key applications

- ✓ Architectural detail
- ✓ Ceiling
- ✓ Direct lighting
- ✓ Downlighting
- ✓ Interior
- ✓ Special effect

Key features

- ✓ Custom lengths
- ✓ Constant Voltage (CV)
- ✓ Diffusion: homogenous
- ✓ Direct view
- ✓ Extensive CCT range
- ✓ IP40 dry area
- ✓ Ledmix RGBW

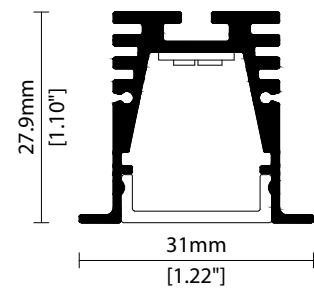

Linear

LINE-R XL RGBW

Specification sheet



Dimensions	H27.9/W31/L141-2016mm (H1.1/W1.22/L5.55-79.37in) (excluding spring clips)
PCB Cut-point	62.5mm increment/2000mm max (2.46in increment/78.74in max)
LED Pitch	10.4mm-192LED/m (0.41in - 59LED/ft)
Chip	RGBW LEDmix
Cover/Optics	Diffused (110°)
CCT	s-line: White: 1900K/2100K/2300K/2500K/2700K/3000K/3500K/4000K/5000K/ RGB: Red 620-625nm/Blue 455-460nm/Green 520-525nm k-line: White: 1900K/2100K/2300K/2500K/2700K/3000K/3500K/4000K/5000K RGB: Red 617-627nm/Blue 464-474nm/Green 515-525nm
LED binning	s-line: White: 2.5-step MacAdam ellipse / RGB: 5nm tolerance k-line: White: 3-step MacAdam ellipse / RGB: 10nm tolerance
CRI	≥ 90 (white only)
Lifetime	50,000 hours @ 25°C (50,000 hours @ 77°F)
Operating temp	T _a = -25 to 50°C (T _c max = 68°C) T _a = -13 to 122°F (T _c max = 154°F)
IP Rating	IP40
Finish	Silver anodised
Mounting	Recessed mounting via spring clip
Power feed	Hardwire tails or male/female connectors
Control	DMX/DALI



LED Grading Key

Exclusive Grade

s-line*
2-step CCT range

*KKDC tuned
CCT range

Base Grade

k-line
3-step commercial range
Energy Star CCTs

Power consumption	Supply voltage	Supply current
20W/m (6.10W/ft)	24V DC	0.83A/m (0.25A/ft)

Diffused Cover

s-line	441lm/m (134lm/ft) 22.0lm/W
k-line	416lm/m (127lm/ft) 20.8lm/W

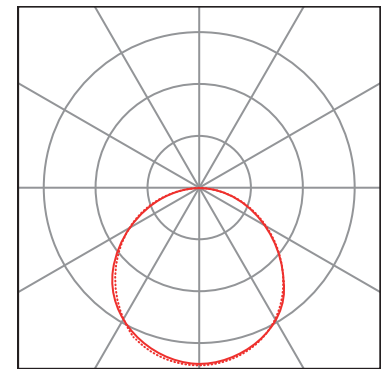
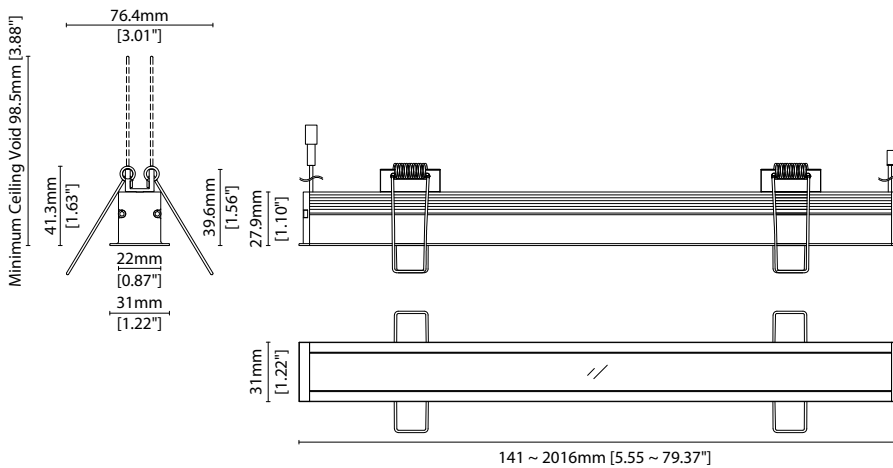

— C0 / C180 cd / 1000 lm - - - C90 / C270

Data derived from independent UKAS / IESNA LM-79-08 accredited testing of production samples.

LINE-R XL RGBW

Code Table



FIXTURE

Model	Finish	Cover	Grade ¹	LED	Colour (CCT)	Length Availability ²	IP	Cable Length	Power Feed ³	Input							
LINE-R XL	RX Silver Anodised	SA Diffused	C	s ⁴ k ⁴	R201	R201	RGB+1900K	19	m 141-2016mm 62.5mm increments	IP40	40	300mm/ 11.81"	0300	Single no sheath tail	S00X	DC 24V	g
							RGB+2100K	21									
							RGB+2300K	23									
							RGB+2500K	25									
							RGB+2700K	27									
							RGB+3000K	30									
							RGB+3500K	35									
							RGB+4000K	40									
							RGB+5000K	50									
										Single no sheath IP20 connector	S20X						
										Double no sheath IP20 connector	D20X						

¹ Refer to **LED Grading Key** on **Specification sheet** page

² Refer to **Length Availability List** or enter total run length instead of length code

³ Refer to **Power Feed Options** on **Options** pages

⁴ LEDmix RGBW requires white colour choice

Code Example:

RX	-	SA	-	C	-	s	-	R201	-	RGBW	-	35	-	m	516	-	40	-	0300	-	D00X	-	g
LINE-R XL		Silver Anodised		Diffused				R201		RGBW		RGB+3500K		516mm		IP40		300mm/11.81"		Double no sheath tail		DC 24V	

ACCESSORIES

Connection Accessories

KKCN-29	5 PIN RGBW male & female 50mm/1.97" pair
KKCN-30	5 PIN RGBW male & female 300mm/11.81" pair
KKCN-32	5 PIN RGBW 1000mm/39.37" extension lead

PSU/Driver

DALI/DMX

* Refer to **Driver/PSU Options** page for details or provide requirement and KKDC to offer the suitable option

* Refer to **Power feed** on **Accessories** pages

LED ENGINE VARIANTS (LED STRIP TYPE)

Colour	LED	Lumen/m	Lumen/ft	W/m	W/ft	Spec Doc	Length	Increment
Single CCT	R007	265	81	7	2.13	LINE-R XL R007	99-2016mm (3.89-79.37in)	41.7mm (3.28in)
	R014	534	163	14	4.27	LINE-R XL R014	99-2016mm (3.89-79.37in)	41.7mm (3.28in)
	R020	731	223	20	6.10	LINE-R XL A020	99-2016mm (3.89-79.37in)	41.7mm (3.28in)
	A040	2000	610	40	12.2	LINE-R XL A040	93-1516mm (3.66-59.68in)	38.46mm (1.51in)
Warm Dim/Dynamic White	R207	594	181	16	4.88	LINE-R XL R207	99-2016mm (3.89-79.37in)	83.3mm (3.28in)
RGB	501	Red 61	Red 19	15.6	4.75	LINE-R XL RGB	99-2016mm (3.89-79.37in)	83.3mm (3.28in)
		Green 132	Green 40					
		Blue 22	Blue 7					
		RGB 192	RGB 59					
RGBW	R201	441	134	20	6.10	LINE-R XL RGBW	141-2016mm (5.55-79.37in)	62.5 (2.46in)

* Performance data: s-line, diffused cover, 3000K + RGB

LINE-R XL RGBW

Length Availability List



Length Code		Fixture Length ¹		LED Strip ²		End Cap Dimension ³		Wattage (W)	Output (lm)
Metric	Imperial(US)	Metric	Imperial(US)	Metric	Imperial(US)	Metric	Imperial(US)		3000K (Test Data)
m0141	i0006	141mm	5.55in	125mm	4.92in	11mm	0.43in	2.50	52
m0204	i0008	204mm	8.01in	188mm	7.38in	11mm	0.43in	3.75	78
m0266	i0010	266mm	10.47in	250mm	9.84in	11mm	0.43in	5.00	104
m0329	i0013	329mm	12.93in	313mm	12.30in	11mm	0.43in	6.25	130
m0391	i0015	391mm	15.39in	375mm	14.76in	11mm	0.43in	7.50	156
m0454	i0018	454mm	17.85in	438mm	17.22in	11mm	0.43in	8.75	182
m0516	i0020	516mm	20.31in	500mm	19.69in	11mm	0.43in	10.00	208
m0579	i0023	579mm	22.78in	563mm	22.15in	11mm	0.43in	11.25	234
m0641	i0025	641mm	25.24in	625mm	24.61in	11mm	0.43in	12.50	260
m0704	i0028	704mm	27.70in	688mm	27.07in	11mm	0.43in	13.75	286
m0766	i0030	766mm	30.16in	750mm	29.53in	11mm	0.43in	15.00	312
m0829	i0033	829mm	32.62in	813mm	31.99in	11mm	0.43in	16.25	338
m0891	i0035	891mm	35.08in	875mm	34.45in	11mm	0.43in	17.50	364
m0954	i0038	954mm	37.54in	938mm	36.91in	11mm	0.43in	18.75	390
m1016	i0040	1016mm	40.00in	1000mm	39.37in	11mm	0.43in	20.00	416
m1079	i0042	1079mm	42.46in	1063mm	41.83in	11mm	0.43in	21.25	442
m1141	i0045	1141mm	44.92in	1125mm	44.29in	11mm	0.43in	22.50	468
m1204	i0047	1204mm	47.38in	1188mm	46.75in	11mm	0.43in	23.75	494
m1266	i0050	1266mm	49.84in	1250mm	49.21in	11mm	0.43in	25.00	520
m1329	i0052	1329mm	52.30in	1313mm	51.67in	11mm	0.43in	26.25	546
m1391	i0055	1391mm	54.76in	1375mm	54.13in	11mm	0.43in	27.50	572
m1454	i0057	1454mm	57.22in	1438mm	56.59in	11mm	0.43in	28.75	598
m1516	i0060	1516mm	59.69in	1500mm	59.06in	11mm	0.43in	30.00	624
m1579	i0062	1579mm	62.15in	1563mm	61.52in	11mm	0.43in	31.25	650
m1641	i0065	1641mm	64.61in	1625mm	63.98in	11mm	0.43in	32.50	676
m1704	i0067	1704mm	67.07in	1688mm	66.44in	11mm	0.43in	33.75	702
m1766	i0070	1766mm	69.53in	1750mm	68.90in	11mm	0.43in	35.00	728
m1829	i0072	1829mm	71.99in	1813mm	71.36in	11mm	0.43in	36.25	754
m1891	i0074	1891mm	74.45in	1875mm	73.82in	11mm	0.43in	37.50	780
m1954	i0077	1954mm	76.91in	1938mm	76.28in	11mm	0.43in	38.75	806
m2016	i0079	2016mm	79.37in	2000mm	78.74in	11mm	0.43in	40.00	832

¹ Actual total overall length of light fixture (LED strip + end caps + void/wire hole)

² Actual length of PCB strip

³ Actual length of 2x end caps

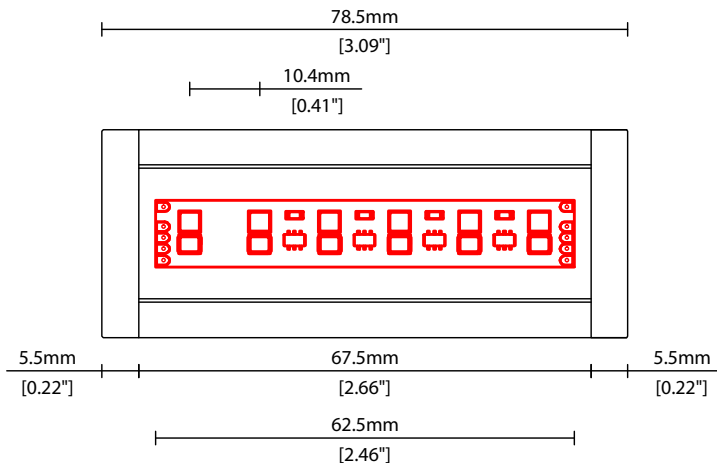



LINI-R XL RGBW Options



COVER/LENS OPTIONS

* Options are an integral part of the fixture ordering codes. Please refer to **Code Table** pages.

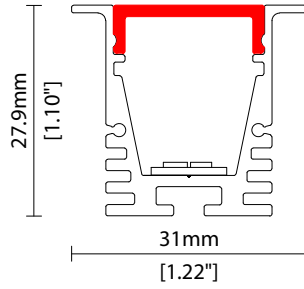

C Diffused cover
W31/H27.9mm (W1.22/H1.10")

POWER FEED OPTIONS

* Options are an integral part of the fixture ordering codes. Please refer to **Code Table** pages.

0300 S00X 300mm (11.81") Single no sheath tail

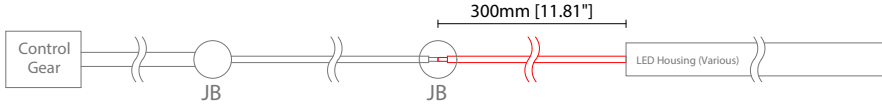

0300 D00X 300mm (11.81") Double no sheath tail

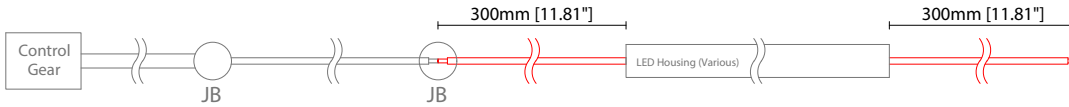

0300 S20X 300mm (11.81") Single no sheath IP20 connector

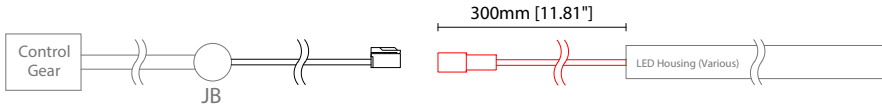

0300 D20X 300mm (11.81") Double no sheath IP20 connector

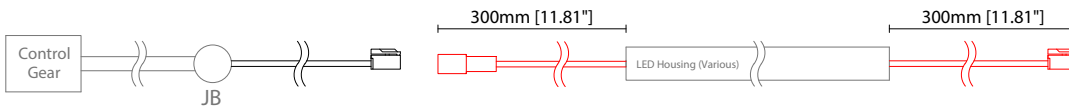

1000 S00X 1000mm (39.37") Single no sheath tail

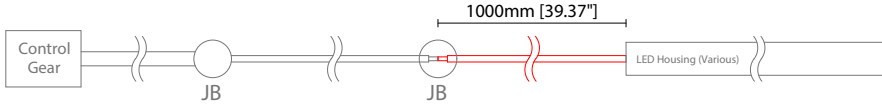

1000 D00X 1000mm (39.37") Double no sheath tail

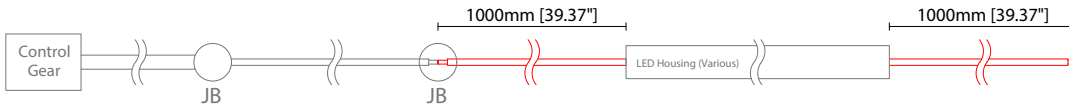

1000 S20X 1000mm (39.37") Single no sheath IP20 connector

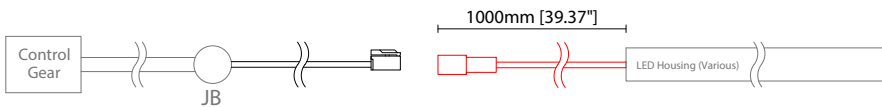

1000 D20X 1000mm (39.37") Double no sheath IP20 connector

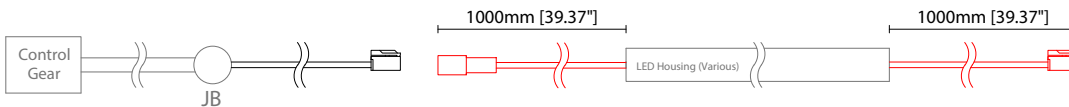

Key

Control Gear Power supply, sub-controllers & control systems

JB Junction box / cable connection

POWER FEED OPTIONS (CONTINUED)

5 Pin RGBW Female Connector

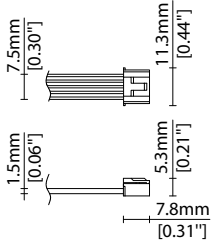

5 Pin RGBW Male Connector

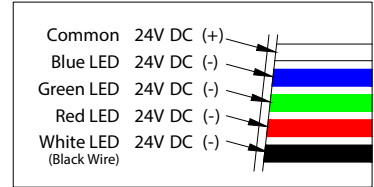
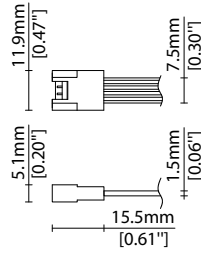

POWER FEED

Note: Accessories are to be ordered separately with corresponding code shown below.

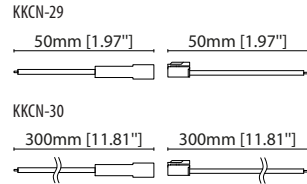
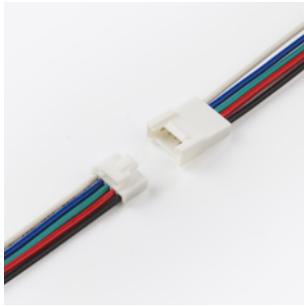

KKCN-29 50mm (1.97in) pair
KKCN-30 300mm (11.81in) pair
5-PIN RGBW male + female
connector set

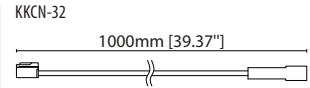

KKCN-32 1000mm (39.37in) pair
5-PIN RGBW male + female
extension lead

KKDC CONTROL



IP20
Plastic housing
L170/W59/H29mm
(L6.69/W2.32/H1.14in)

KKDM-06 1-10V
visDIM dimmable sub-controller
(4 x 8A max @ 12-36V)



IP20
Plastic housing
L170/W53.4/H28mm
(L6.69/W2.10/H1.10in)

KKSC-05 DMX
visDIM dimmable sub-controller
(4 x 5A max @ 12-36V)



IP20
Plastic housing
L170/W59/H29mm
(L6.69/W2.32/H1.14in)

KKDL-02 DALI
visDIM dimmable sub-controller
(4 x 8A max @ 12-36V)



IP20
Plastic housing
L166/W53.4/H23mm
(L6.54/W2.10/H0.91in)

KKDL-03 DALI
visDIM dimmable sub-controller
(4 x 5A max @ 12-36V)

AVAILABLE PSU OPTIONS

Control Mode	PSU (Order Code)	Input Voltage AC	Output Voltage DC	Rated Output Current	Rated Power	Dim %	IP Rating
Switched	CEN-60-24	90-295V	24V	2.5A	60W	-	IP67
	HLG-60H-24	90-305V	24V	2.5A	60W	-	IP67
	HLG-100H-24	90-305V	24V	4.0A	100W	-	IP67
	HLG-150H-24	90-305V	24V	6.3A	150W	-	IP67
	HLG-240H-24	90-305V	24V	10A	240W	-	IP67
0-10V (1-10V)	PWM-40-24	90-305V	24V	1.67A	40W	100-0.15 (100-10)	IP67
	PWM-60-24	90-305V	24V	2.5A	60W	100-0.15 (100-10)	IP67
	PWM-90-24	90-305V	24V	3.67A	90W	100-0.15 (100-10)	IP67
	PWM-120-24	90-305V	24V	5.0A	120W	100-0.15 (100-10)	IP67
DALI	LIN100A1	120-277V	24V	1A per channel	100W	100-0.1	IP66/IP40
DMX RGB	LIN100A1	120-277V	24V	1.33A per channel	100W	100-0.1	IP66/IP40
DMX RGBW	LIN100A1	120-277A	24V	1A per channel	100W	100-0.1	IP66/IP40

Flicker Free Options - Combination of PSU+ sub-controller

Control Mode	PSU (Order Code)	Sub-controller (Order Code)	Input Voltage AC	Output Voltage DC	Rated Output Current	Rated Power	Dim %	IP Rating PSU/ Sub-controller
0-10V or 1-10V	CEN-60-24	KKDM-06	90-295V	24V	2.5A	60W	100-0.9	IP67/IP20
	HLG-60H-24	KKDM-06	90-295V	24V	2.5A	60W	100-0.9	IP67/IP20
	HLG-100H-24	KKDM-06	90-295V	24V	4.0A	100W	100-0.9	IP67/IP20
	HLG-150H-24	KKDM-06	90-295V	24V	6.3A	150W	100-0.9	IP67/IP20
	HLG-240H-24	KKDM-06	90-295V	24V	10.0A	240W	100-0.9	IP67/IP20
DALI	CEN-60-24	KKDL-02/03	90-295V	24V	2.5A	60W	100-0.1	IP67/IP20
	HLG-60H-24	KKDL-02/03	90-305V	24V	2.5A	60W	100-0.1	IP67/IP20
	HLG-100H-24	KKDL-02/03	90-305V	24V	4.0A	100W	100-0.1	IP67/IP20
	HLG-150H-24	KKDL-02/03	90-305V	24V	6.3A	150W	100-0.1	IP67/IP20
	HLG-240H-24	KKDL-02/03	90-305V	24V	10.0A	240W	100-0.1	IP67/IP20
DMX RGB	CEN-60-24	KKSC-05	90-295V	24V	2.5A	60W	100-0.9	IP67/IP20
	HLG-60H-24	KKSC-05	90-305V	24V	2.5A	60W	100-0.9	IP67/IP20
	HLG-100H-24	KKSC-05	90-305V	24V	4A	100W	100-0.9	IP67/IP20
	HLG-150H-24	KKSC-05	90-305V	24V	6.3A	150W	100-0.9	IP67/IP20
	HLG-240H-24	KKSC-05	90-305V	24V	10.0A	240W	100-0.9	IP67/IP20

¹ The items shown above cover the most frequently used specification but does not exhaust the possible options

² PSU and/or driver can be chosen from the table, or KKDC may recommend the best option upon receipt of the controls requirement and installation environment

³ Electrical shop drawing will include detailed information of PSU and relevant control drivers

⁴ Cut sheets are available on the controls section of www.kkdc.lighting or upon request